

modello  
**Barocco**



“ Il dinamismo delle forme,  
l'esuberanza decorativa, la ricerca dell'effetto ...

*The dynamism of the shapes, the decorative exuberance,  
the search for the effect...*

”

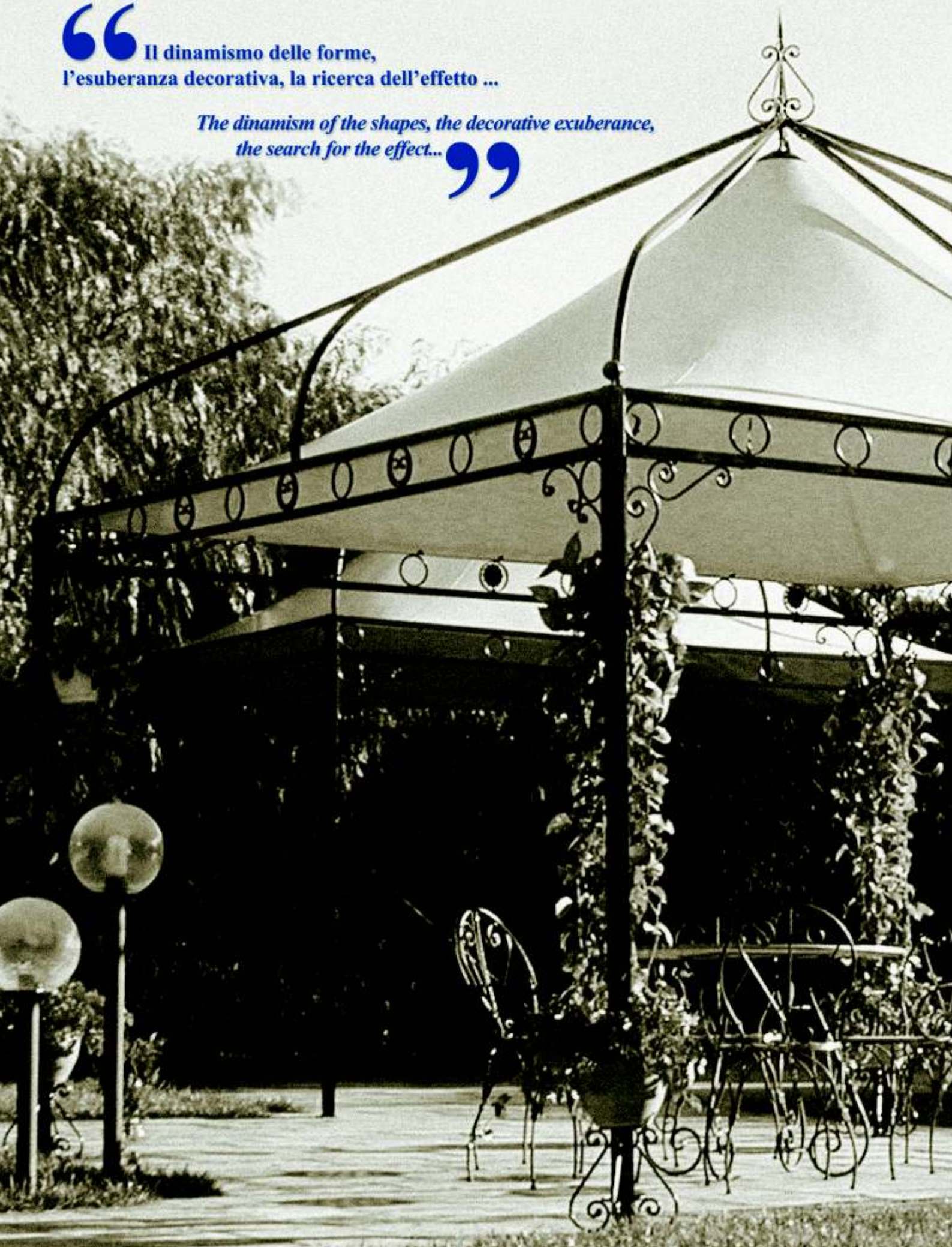

Optionals decorativi - Decorative optionals

decorazioni per il traliccio perimetrale mod. Barocco  
decorations for the perimetrical beam of the Barocco model



Squadri angolari - Angular ornament



Optionals decorativi - Decorative optionals

## Ornati di colmo - Apex decoration



## decorazione angolare - Angular decoration

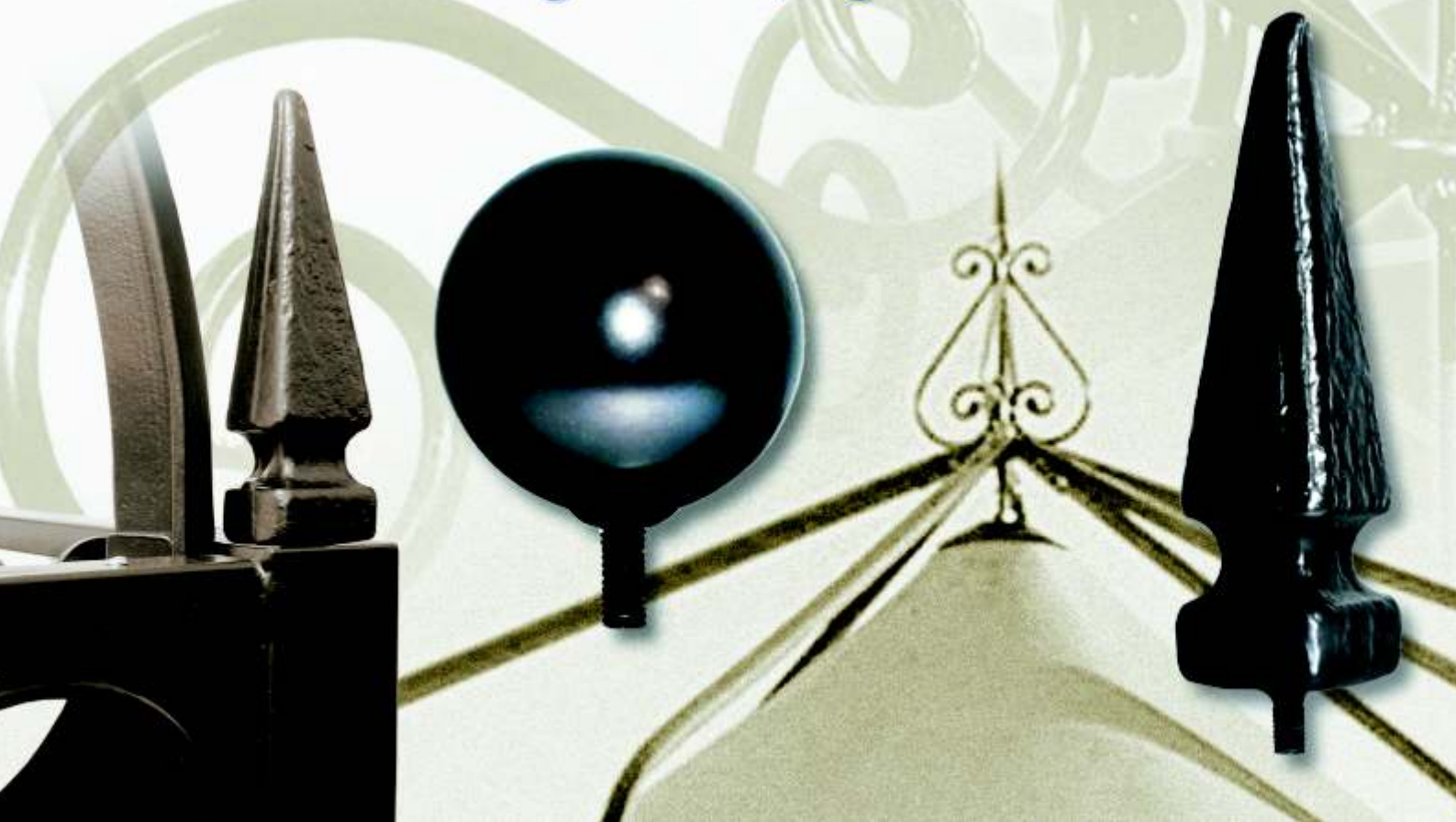

Optionals decorativi - Decorative optionals

# Decorazione al piede The foot decoration



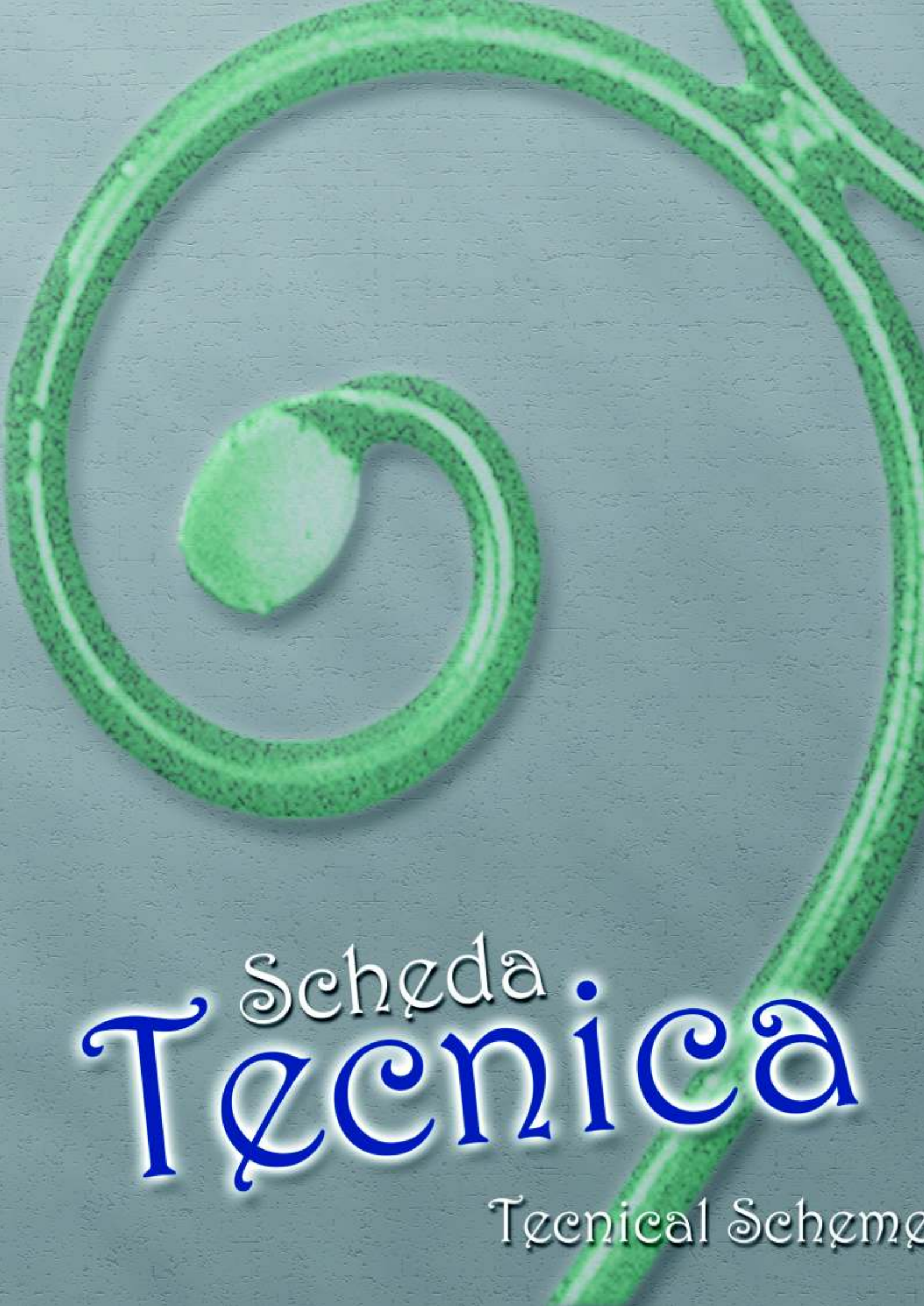

Schēda  
**Tēcnica**

Tēcnica Schēma

# MODELLO Barocco

## STRUTTURA SEMPLICE BASIC STRUCTURE

### MODEL Barocco

mod. **Barocco quadrato** con struttura in acciaio zincato e verniciato e telo di copertura in PVC ignifugo.  
**Squared model Barocco** with structure of galvanized and powder coated steel and fire-retardant PVC-covering.

Lato / side	m <sup>2</sup>	codice / code	A	H	HI	Massima lunghezza maximal length	∓ m <sup>3</sup>	∓ Kg	n° colli # pieces
m 3.00	9	SBAQ300_EI	3.00	2.28	1.60	3.00	0.52	162	8
m 4.00	16	SBAQ400_EI	4.00	2.28	1.85	4.00	0.76	214	10
m 5.00	25	SBAQ500_EI	5.00	2.28	1.87	5.00	1.06	238	10

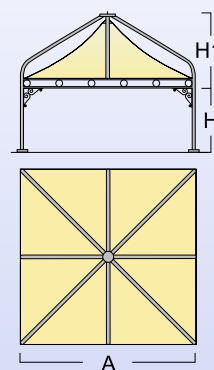

mod. **Barocco rettangolare** con struttura in acciaio zincato e verniciato e telo di copertura in PVC ignifugo.  
**Rectangular model Barocco** with structure of galvanized and powder coated steel and fire-retardant PVC-covering.

Lato / side	m <sup>2</sup>	codice / code	A	AI	H	HI	Massima lunghezza maximal length	∓ m <sup>3</sup>	∓ Kg	n° colli # pieces
m 3.00 x 4.00	12	SBAR3X4_EI	3.00	4.00	2.28	1.83	4.00	0.63	190	9
m 3.00 x 5.00	15	SBAR3X5_EI	3.00	5.00	2.28	1.98	5.00	0.72	207	9
m 4.00 x 5.00	20	SBAR4X5_EI	4.00	5.00	2.28	2.12	5.00	0.82	223	10

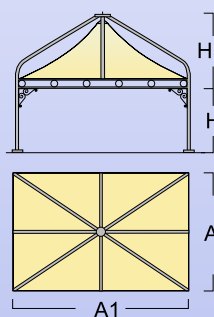

### Elementi di serie per la struttura semplice: / Standard elements of the basic structure

- 1) Traliccio perimetrale standard (4 pz.);  
Standard perimetrical beams (4 pieces);
- 2) Montanti (4 pz.);  
Pillars (4 pieces);
- 3) Telo di copertura in PVC ignifugo beige RAL 1013;  
Fire-retardant beige RAL 1013 PVC-cover;
- 4) Squadri angolari decorativi (8 pz.) SQ.S\_1 - SQ.S\_2  
Decorative angular junctions (8 pieces) SQ.S\_1 - SQ.S\_2
- 5) \*Puntoni inclinati;  
\*Inclined rafters;
- 6) Giunzione di colmo (con decorazione standard) COS\_1 - COS\_2  
Apex junction (with standard decoration) COS\_1 - COS\_2
- 7) Decorazioni per angolo (4 pz.) AN.S\_1 - AN.S\_2  
Angular decorations (4 pieces) AN.S\_1 - AN.S\_2
- 8) Piedi regolabili (4 pz.);  
Adjustable legs (4 pieces);

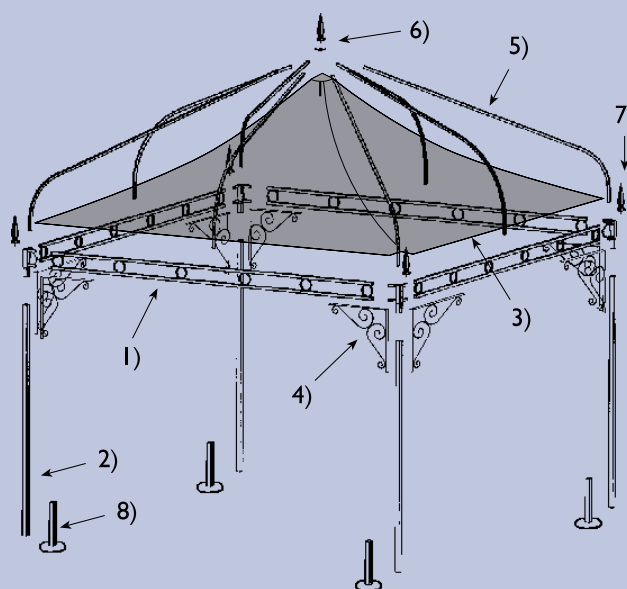

**\*NB: la struttura standard con lato di m 3.00 non comprende i puntoni inclinati centrali.**

**\*PS: Standard structure side m 3.00 does not include the central inclined rafters**

# MODELLO Barocco

## STRUTTURA ACCESSORIATA

FULLY EQUIPPED STRUCTURE

## MODEL Barocco

### Componenti per la struttura accessoriata: / Standard elements of the equipped structure

- 1) Traliccio perimetrale standard (4 pz.);  
*Standard perimetrical beams (4 pieces);*
- 2) Montanti (4 pz.);  
*Pillars (4 pieces);*
- 3) Telo di copertura in PVC ignifugo beige RAL 1013;  
*Fire-retardant beige RAL 1013 PVC-cover;*
- 4) Squadri angolari decorativi (8 pz.) SQ.S\_1 - SQ.S\_2  
*Decorative angular junctions (8 pieces) SQ.S\_1 - SQ.S\_2*
- 5) \*Puntoni inclinati;  
*\*Inclined rafters;*
- 6) Ornato di colmo CO.O\_3  
*Apex decoration CO.O\_3*
- 7) Decorazione per angolo (4 pz.) AN.S\_1 - AN.S\_2  
*Angular decorations (4 pieces) AN.S\_1 - AN.S\_2*
- 8) Piedi regolabili (4 pz.);  
*Adjustable legs (4 pieces.);*
- 9) Ornato al piede (4 pz.) PI.O\_1  
*Foot decoration (4 pieces) PI.O\_1*
- 10) Vaso in terracotta (4 pz. mod. 1) VA.O\_1  
*Terracotta pot (4 pieces mod. 1) VA.O\_1*
- 11) Decorazioni sul traliccio perimetrale  
TB.O1 - TB.O2 - TB.O3 - TB.O4  
*Decorations of the perimetrical beam  
TB.O1 - TB.O2 - TB.O3 - TB.O4*

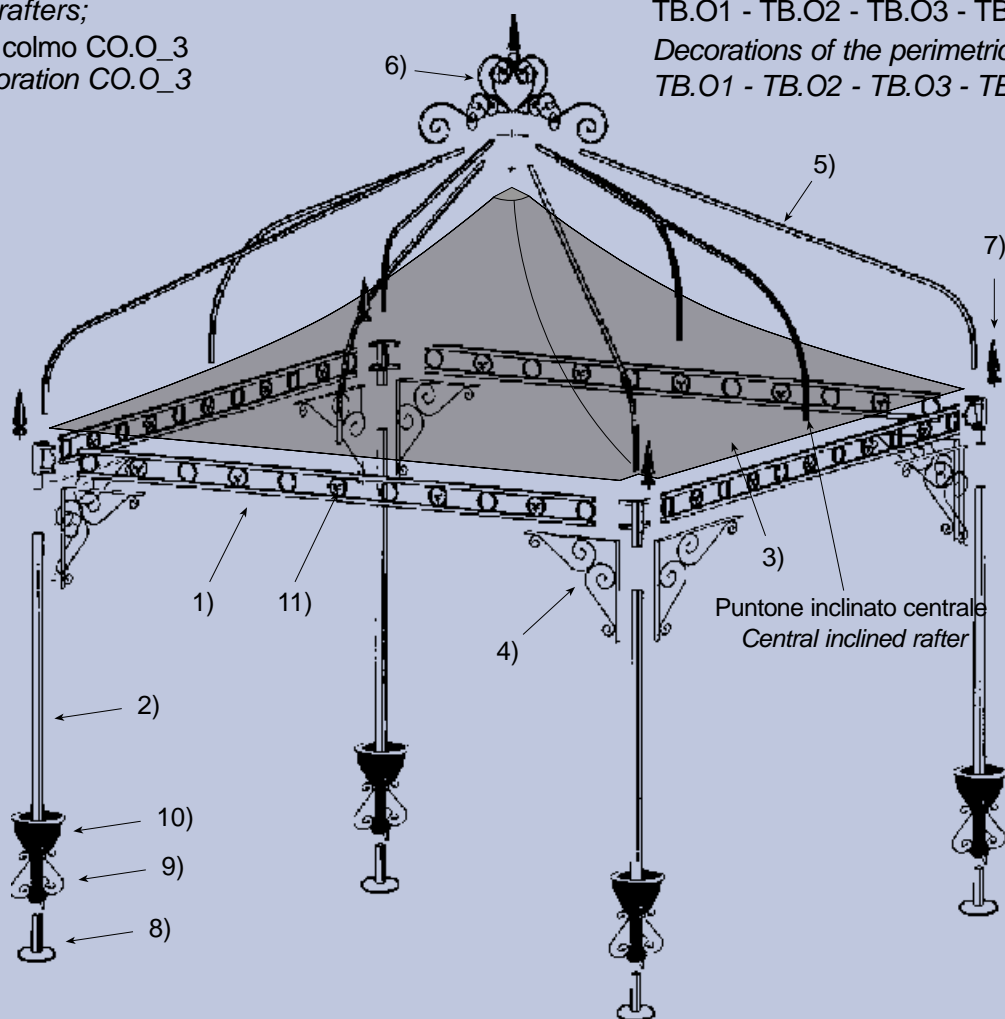



**\*NB:** la struttura standard con lato di m 3.00 non comprende i puntoni inclinati centrali.

**\*PS:** Standard structure side m 3.00 does not include the central inclined rafters.



# Personalizza il tuo gazebo modello **Barocco**

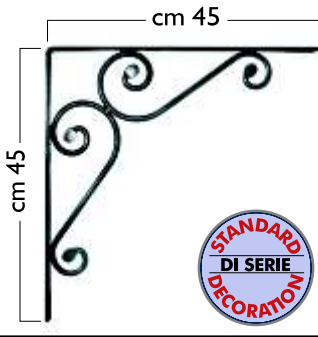
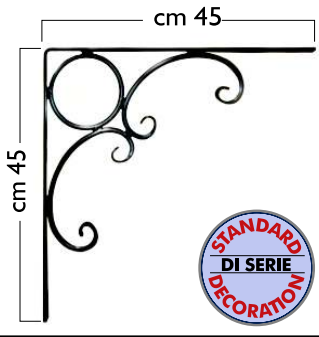
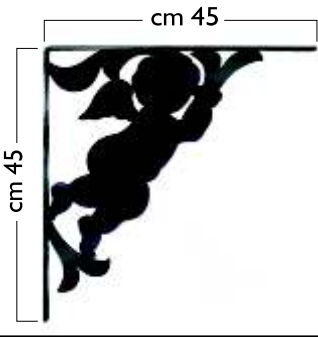

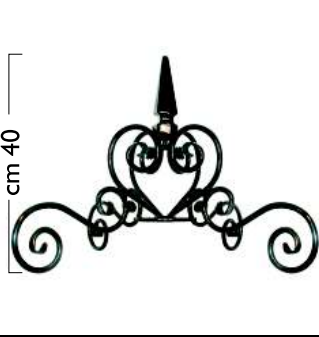
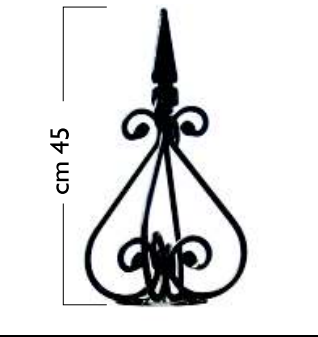
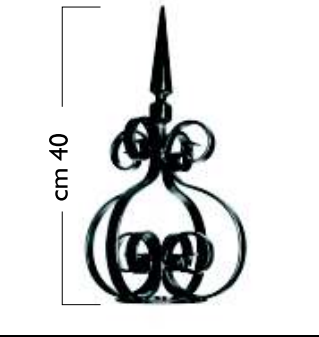

*Customize your Barocco model gazebo*

Squadri angolari / Angular decoration			Ornato del piede / Foot decoration
			
codice / code	codice / code	codice / code	codice / code
SQ.S_1	SQ.S_2	SQ.O_5	PI.O_1





*Customize your Barocco model gazebo*

Base del piede / Bottom leg	l'Ornato di colmo / Apex decoration		
			
codice / code	codice / code	codice / code	codice / code
PI.O_2	CO.O_3	CO.O_4	CO.O_5

*Scegli le decorazioni e gli accessori che preferisci.*

Decorazione per angolo / Angular decoration		Decorazione di colmo / Apex decoration	
			
codice / code	codice / code	codice / code	codice / code
AN.S_1	AN.S_2	CO.S_1	CO.S_2

*Choose the accessories and decoration you prefer*

Foglia interna / Inside leaf	Porta lume / Lampe holder	Vaso terracotta / Terracotta pot	Vaso terracotta smaltata / Glazed terracotta pot
			
codice / code	codice / code	codice / code	codice / code
FLO_1	PL.O_1	VA.O_1	VA.O_2

# Decora il traliccio perimetrale del tuo gazebo modello Barocco

*Customize the perimetrical beam of your Barocco model gazebo*

## Traliccio perimetrale standard / Standard perimetrical beam

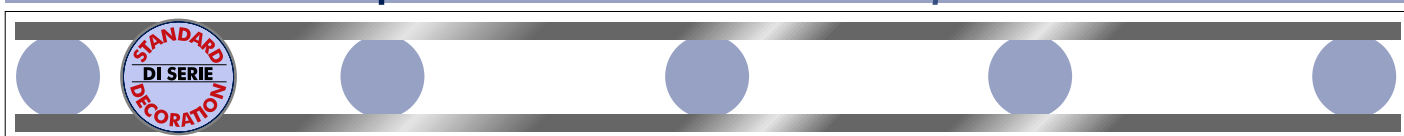

A richiesta è possibile arricchire il traliccio perimetrale alternando diversi elementi decorativi  
 On request it is possible to enrich the perimetrical beam by switching different decorative applications

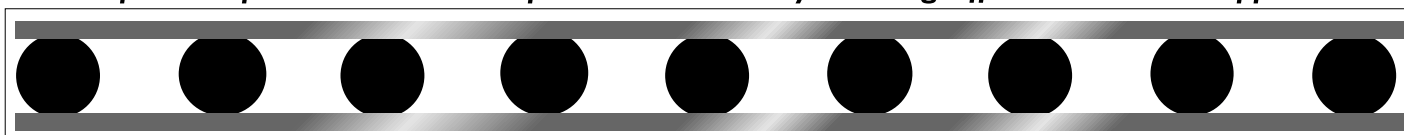

## Quantità di elementi decorativi per i lati 3.00 - 4.00 - 5.00 m Quantity of decorative applications for the sides 3.00 - 4.00 - 5.00 m

m 3.00: n° 4 elementi decorativi  
 m 3.00: n° 4 decorative applications

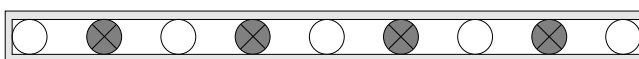

m 4.00: n° 5 elementi decorativi  
 m 4.00: n° 5 decorative applications

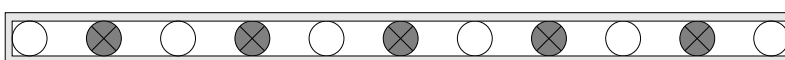

m 5.00: n° 6 elementi decorativi  
 m 5.00: n° 6 decorative applications

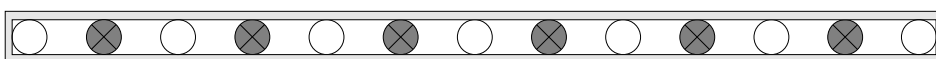

## Decorazioni per traliccio perimetrale / Choice of decorations for the perimetrical beam

codice / code	codice / code	codice / code	codice / code
TB.O_1	TB.O_2	TB.O_3	TB.O_4

### Codici trave con decorazione 1 / Beam codes with decoration 1

lato / side	quantità quantity	codice / code	$\geq$ Kg
300	4	TB.O300_1	15.5
400	5	TB.O400_1	19.5
500	6	TB.O500_1	23.5

### Codici trave con decorazione 2 / Beam codes with decoration 2

lato / side	quantità quantity	codice / code	$\geq$ Kg
300	4	TB.O300_2	15.5
400	5	TB.O400_2	19.5
500	6	TB.O500_2	23.5

### Codici trave con decorazione 3 / Beam codes with decoration 3

lato / side	quantità quantity	codice / code	$\geq$ Kg
300	4	TB.O300_3	15.5
400	5	TB.O400_3	19.5
500	6	TB.O500_3	23.5

### Codici trave con decorazione 4 / Beams codes with decoration 4

lato / syde	quantità quantity	codice / code	$\geq$ Kg
300	4	TB.O300_4	15.5
400	5	TB.O400_4	19.5
500	6	TB.O500_4	23.5

# modello Liberty

“ Il gusto per la sottigliezza, l'ordine,  
le linee curve ispirate alle forme sinuose del mondo vegetale.

*The taste for the subtlety, the order,  
the curved lines inspired by the sinuous shapes  
of the vegetable world.*

”





# MODELLO Liberty

## STRUTTURA SEMPLICE BASIC STRUCTURE

### MODEL Liberty

**mod. Liberty quadrato** con struttura in acciaio zincato e verniciato e telo di copertura in PVC ignifugo  
**Squared model Liberty** with structure of galvanized and powder coated steel and fire-retardant PVC-covering

Lato / side	m <sup>2</sup>	codice / code	A	H	HI	Massima lunghezza maximal length	☐ ≅ m <sup>3</sup>	📦 ≅ Kg	n° colli # pieces
m 3.00	9	SLIQ300_EI	3.00	2.28	1.60	3.00	0.52	197	8
m 4.00	16	SLIQ400_EI	4.00	2.28	1.85	4.00	0.76	250	10
m 5.00	25	SLIQ500_EI	5.00	2.28	1.87	5.00	1.06	303	10

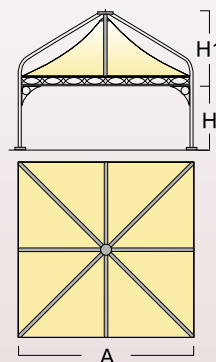

**mod. Liberty rettangolare** con struttura in acciaio zincato e verniciato e telo di copertura in PVC ignifugo  
**Rectangular model Liberty** with structure of galvanized and powder coated steel and fire-retardant PVC-covering

Lato / side	m <sup>2</sup>	codice / code	A	AI	H	HI	Massima lunghezza maximal length	☐ ≅ m <sup>3</sup>	📦 ≅ Kg	n° colli # pieces
m 3.00 x 4.00	12	SLIR3X4_EI	3.00	4.00	2.28	1.83	4.00	0.63	215	9
m 3.00 x 5.00	15	SLIR3X5_EI	3.00	5.00	2.28	1.98	5.00	0.72	257	9
m 4.00 x 5.00	20	SLIR4X5_EI	4.00	5.00	2.28	2.12	5.00	0.82	280	10

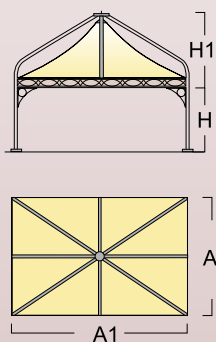

### Elementi di serie per la struttura semplice: / Standard elements for the basic structure

- 1) Traliccio perimetrale standard (4 pz.);  
Standard perimetrical beams (4 pieces);
- 2) Montanti (4 pz.);  
Pillars (4 pieces);
- 3) Telo di copertura in PVC ignifugo beige RAL 1013;  
Fire-retardant beige RAL 1013 PVC-cover;
- 4) Squadri angolari decorativi (8 pz.) SQ.S\_3 - SQ.S\_4  
Decorative angular junctions (8 pieces) SQ.S\_3 - SQ.S\_4
- 5) \*Puntoni inclinati;  
\*Inclined rafters;
- 6) Giunzione di colmo (con decorazione standard) CO.S\_1 - CO.S\_2  
Apex junction (with standard decoration) CO.S\_1 - CO.S\_2
- 7) Decorazioni per angolo (4 pz.) AN.S\_1 - AN.S\_2  
Angular decorations (4 pieces) AN.S\_1 - AN.S\_2
- 8) Piedi regolabili (4 pz.);  
Adjustable legs (4 pieces);

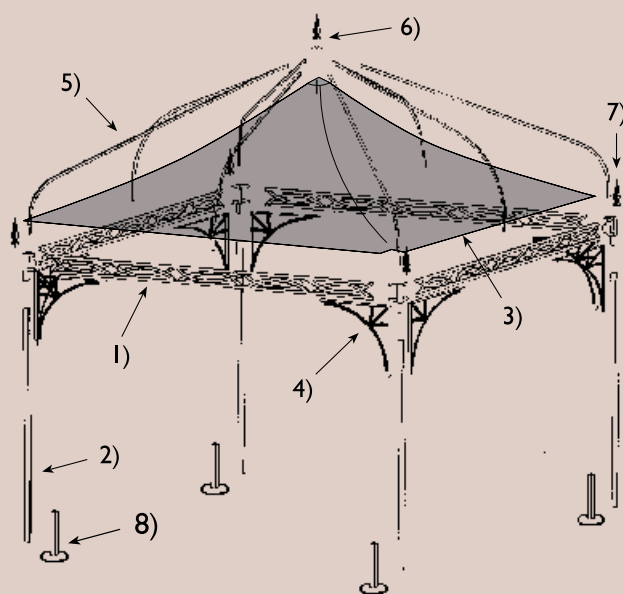

**\*NB: La struttura standard con lato di m 3.00 non comprende i puntoni inclinati centrali.**

**\*PS: Standard structure side m 3.00 does not include the central inclined rafters**

# MODELLO Liberty

## STRUTTURA ACCESSORIATA FULLY EQUIPPED STRUCTURE

### MODEL Liberty

#### Componenti per la struttura accessoriata: / elements of the equipped structure

- 1) Traliccio perimetrale standard (4 pz.);  
*Standard perimetrical beams (4 pieces);*
- 2) Montanti (4 pz.);  
*Pillars (4 pieces);*
- 3) Telo di copertura in PVC ignifugo beige RAL 1013;  
*Fire-retardant beige RAL 1013 PVC-cover;*
- 4) Squadri angolari decorativi (8 pz.) SQ.S\_3 - SQ.S\_4  
*Decorative angular junctions (8 pieces) SQ.S\_3 - SQ.S\_4*
- 5) \*Puntoni inclinati;  
*\*Inclined rafters;*
- 6) Ornato di colmo CO.O\_6  
*Apex decoration CO.O\_6*
- 7) Decorazione per angolo (4 pz.) AN.S\_1 - AN.S\_2  
*Angular decorations (4 pieces) AN.S\_1 - AN.S\_2*
- 8) Piedi regolabili (4 pz.);  
*Adjustable legs (4 pieces.);*
- 9) Ornato al piede (4 pz.) PI.O\_1  
*Foot decoration (4 pieces) PI.O\_1*
- 10) Vaso in terracotta (4 pz. mod. 1) VA.O\_1  
*Terracotta pot (4 pieces mod. 1) VA.O\_1*

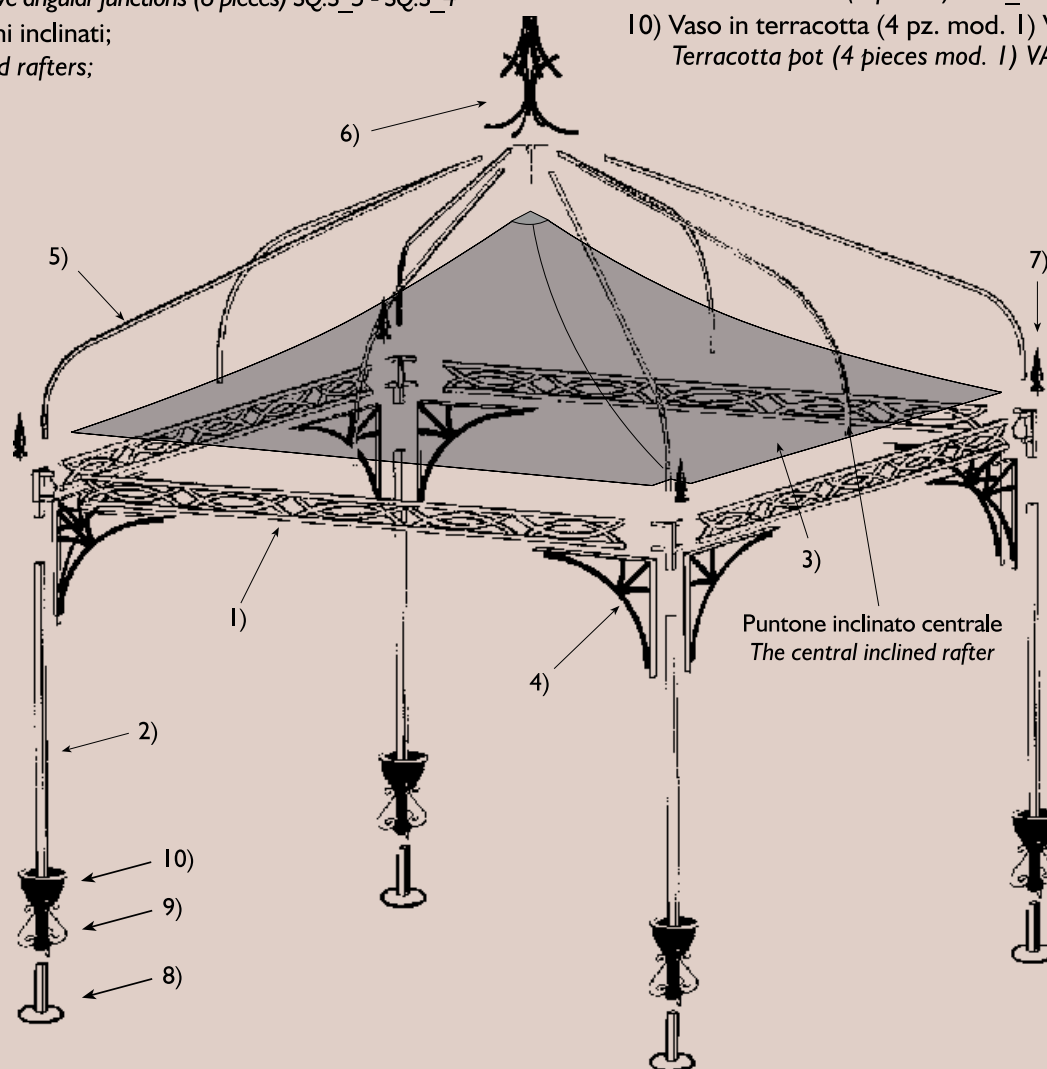

\*NB: la struttura standard con lato di m 3.00 non comprende i puntoni inclinati centrali.

\*NB: Standard structure side m 3.00 does not include the central inclined rafters

# Personalizza il tuo ga

## Traliccio perimetrale mod. Liberty / Perimetrical beam, Liberty model



### Decorazioni di colmo / Apex decorations

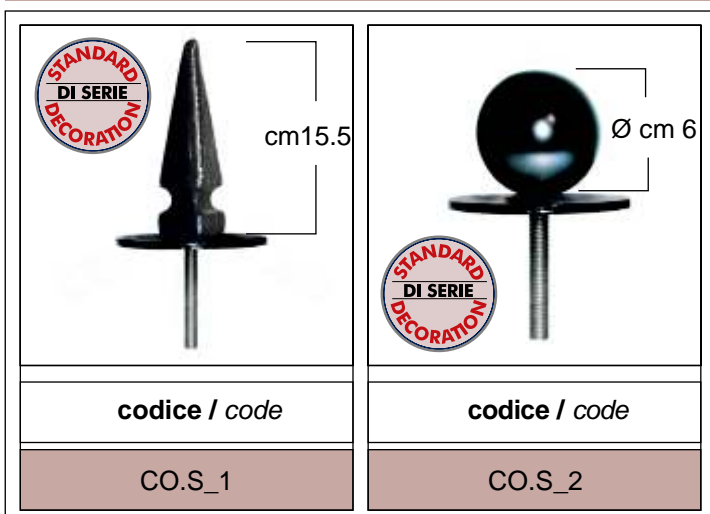

Scegli le decorazioni e gli accessori che preferisci.

Choose the accessories and decoration you prefer

### Decorazione per angolo / Angular decoration

### Ornato al piede / Foot decoration

### Base del piede / Bottom leg

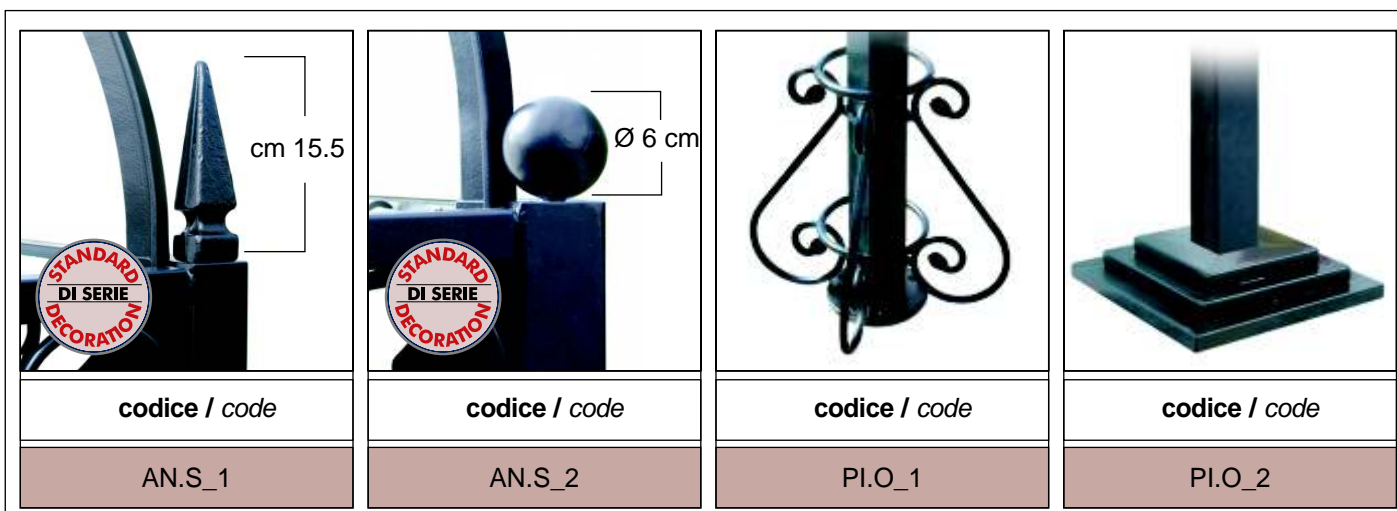



# Personalizza il tuo gazebo modello Liberty

## Traliccio perimetrale mod. Liberty / Perimetrical beam, Liberty model

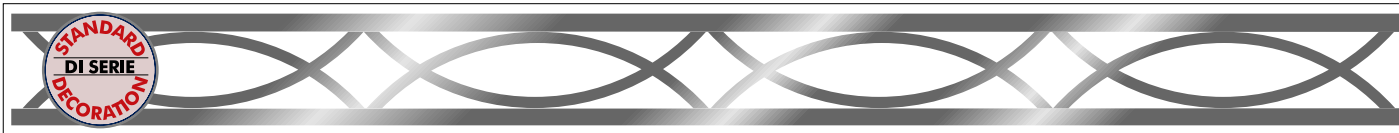

### Decorazioni di colmo / Apex decorations

codice / code	codice / code
CO.S_1	CO.S_2

*Scegli le decorazioni e gli accessori che preferisci.*

*Choose the accessories and decoration you prefer*

## Customize your Liberty model gazebo

### Squadri angolari / Angular ornaments

codice / code	codice / code	codice / code	codice / code
SQ.S_3	SQ.S_4	SQ.O_5	CO.O_6

### Ornato di colmo / Apex decoration

### Decorazione per angolo / Angular decoration

codice / code	codice / code
AN.S_1	AN.S_2

### Ornato al piede / Foot decoration

codice / code	codice / code
PI.O_1	PI.O_2

### Foglia interna / Inside leaf

codice / code
FI.O_1

### Porta lume / Lamp holder

codice / code
PL.O_1

### Vaso terracotta / Terracotta pot

codice / code
VA.O_1

### Vaso terracotta smaltata / Glazed terracotta pot



codice / code
VA.O_2

# Altri accessori applicabili su entrambi i modelli

## Different accessories available for both models



### Telo in tessuto acrilico / Water proof acrylic fabric

#### Telo in tessuto acrilico per modello quadrato Water proof acrylic fabric, squared model

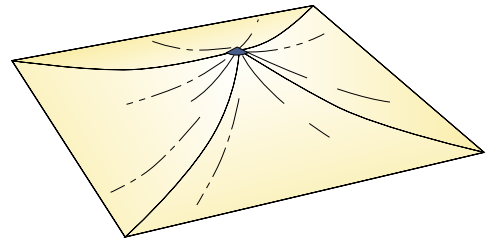
Lato / side	m <sup>2</sup>	codice / code	 $\simeq$ m <sup>3</sup>	 $\simeq$ Kg	n° colli # pieces
m 3.00	9	TI.O300_T	0.08	10	1
m 4.00	16	TI.O400_T	0.08	16	1
m 5.00	25	TI.O500_T	0.08	21	1



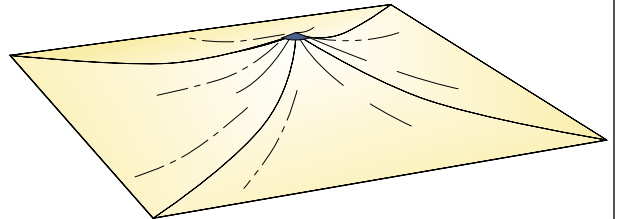

#### Telo in tessuto acrilico per modello rettangolare Water proof acrylic fabric, rectangular model

Lato / side	m <sup>2</sup>	codice / code	 $\simeq$ m <sup>3</sup>	 $\simeq$ Kg	n° colli # pieces
m 3.00 x 4.00	12	TI.O3X4_T	0.08	13	1
m 3.00 x 5.00	15	TI.O3X5_T	0.08	15,5	1
m 4.00 x 5.00	20	TI.O4X5_T	0.08	18,5	1



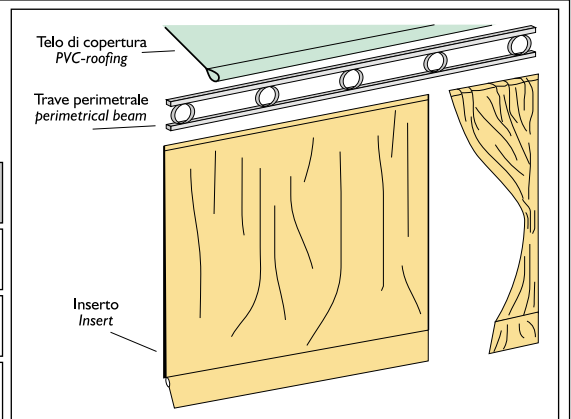

### Chiusura laterale in tessuto acrilico Fabric acrylic lateral

Lato / side	codice / code	Massima lunghezza maximal length	 $\simeq$ m <sup>3</sup>	 $\simeq$ Kg	n° colli # pieces
m 3.00	LF.O300_T	3.00	0.08	6,5	2
m 4.00	LF.O400_T	4.00	0.08	9	2
m 5.00	LF.O500_T	5.00	0.08	11,5	2



### Chiusura laterale in PVC ignifugo Fire-retardant PVC lateral

Lato / side	codice / code	Massima lunghezza maximal length	 $\simeq$ m <sup>3</sup>	 $\simeq$ Kg	n° colli # pieces
m 3.00	LF.O300_I	3.00	0.08	8	2
m 4.00	LF.O400_I	4.00	0.08	11	2
m 5.00	LF.O500_I	5.00	0.08	14	2

