

1

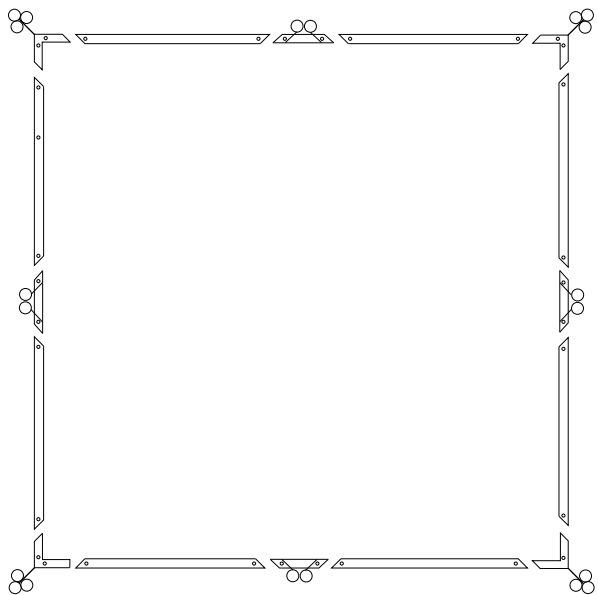

Posizionare i giunti d'angolo, i giunti centrali e le travi come indicato nella figura facendo attenzione che i cavallotti posti sulle travi siano rivolti verso l'esterno e che il foro posizionato sulle estremità delle barre si trovi verso l'alto.

2

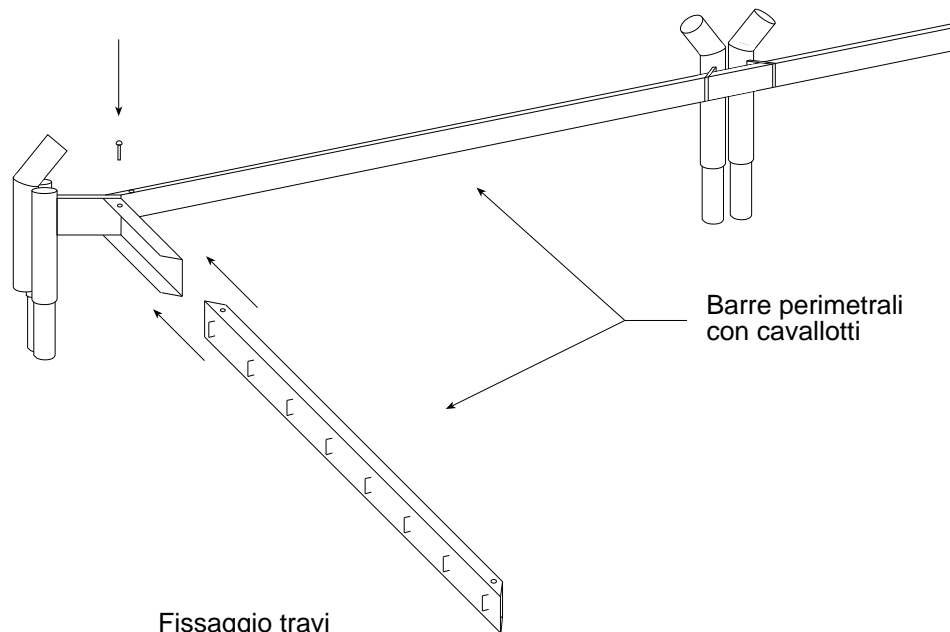

Fissaggio travi
Beams connection

3

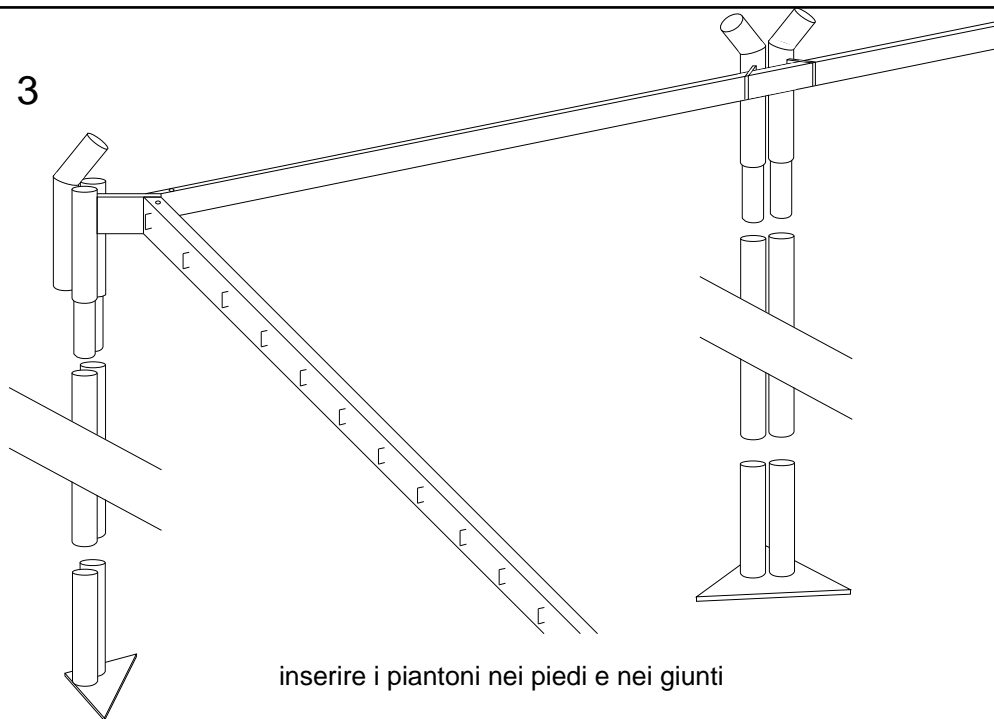

inserire i piantoni nei piedi e nei giunti

4

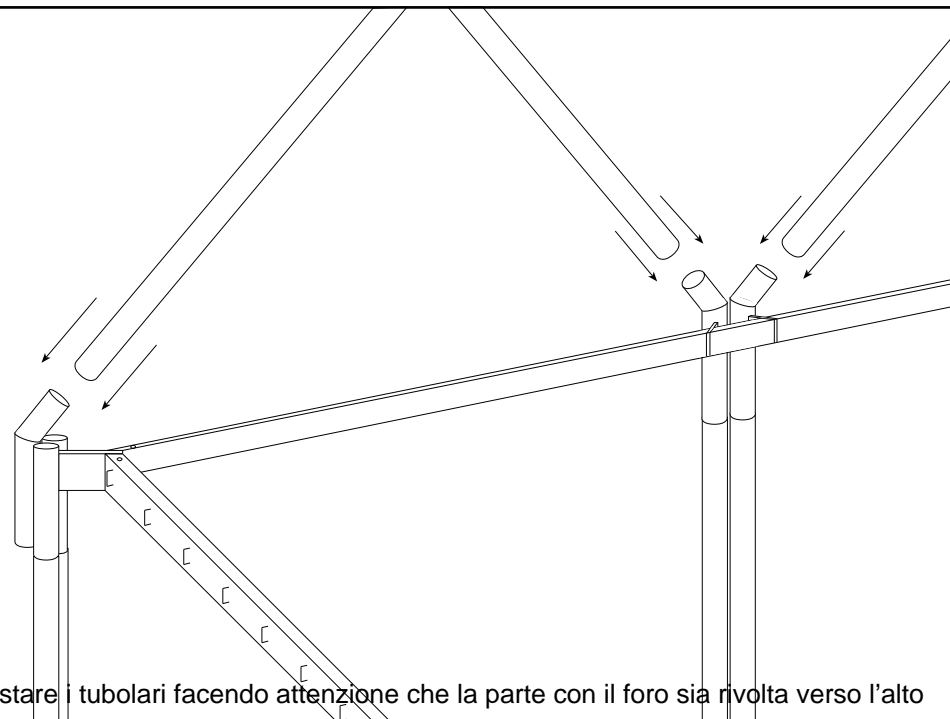

innestare i tubolari facendo attenzione che la parte con il foro sia rivolta verso l'alto

5

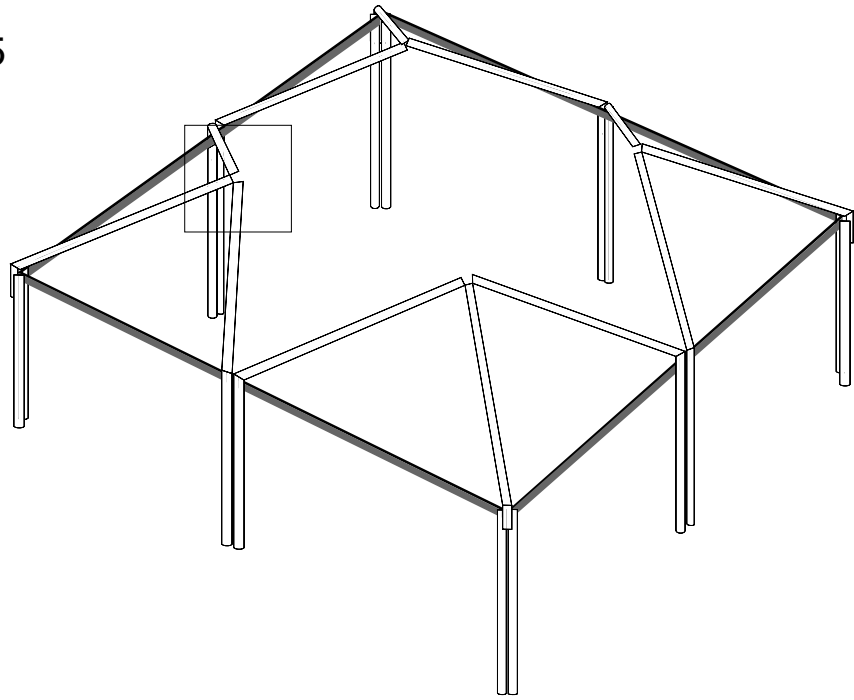

6

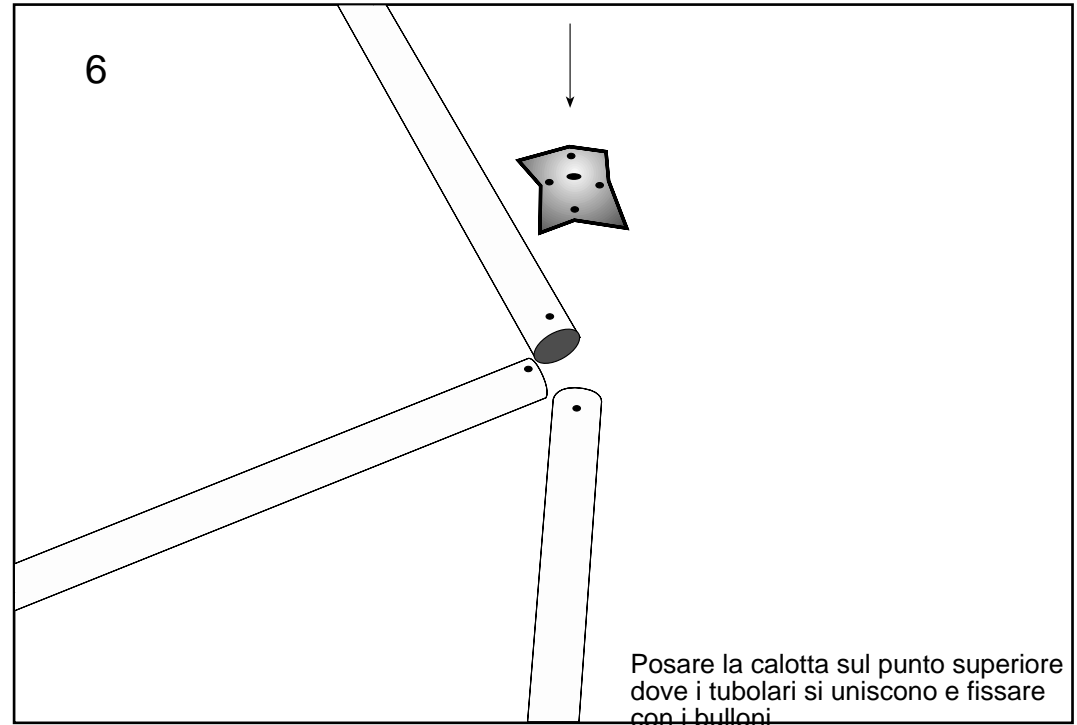

7

Fissare il raccordo per i tubolari orizzontali

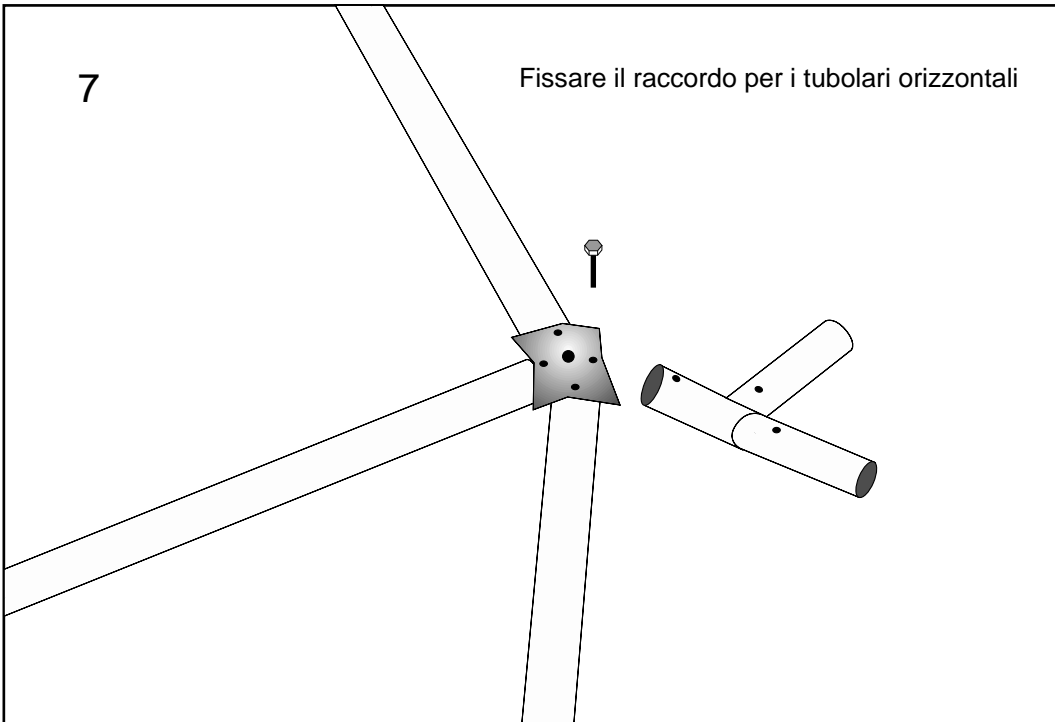

8

fissare i tubolari orizzontali

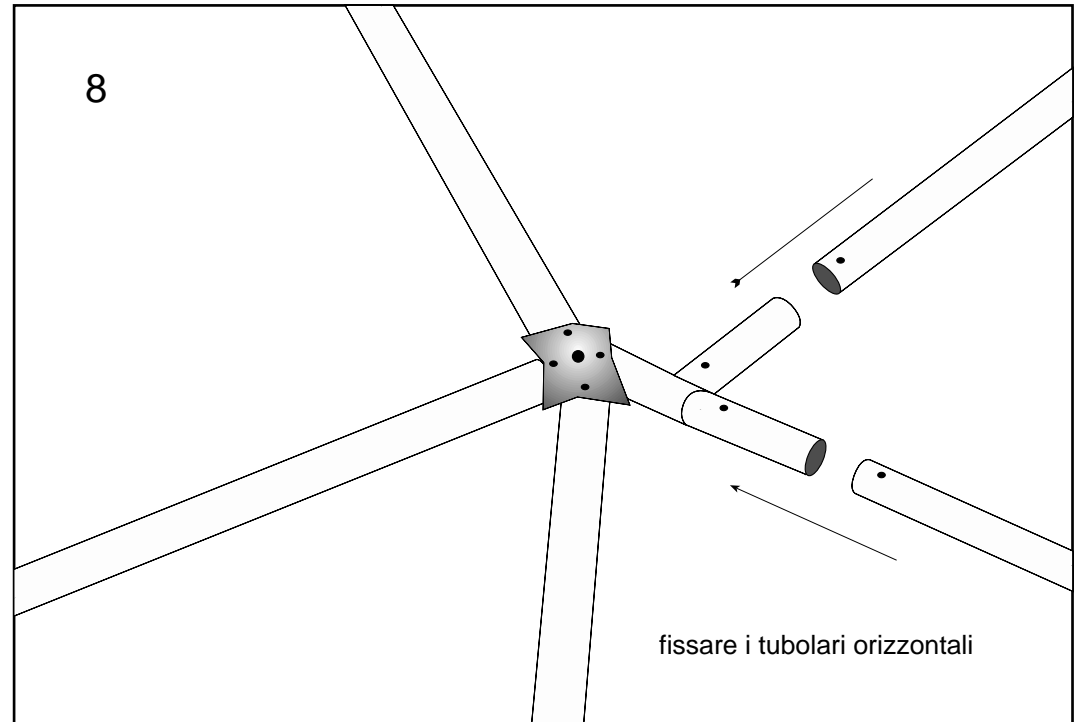

9

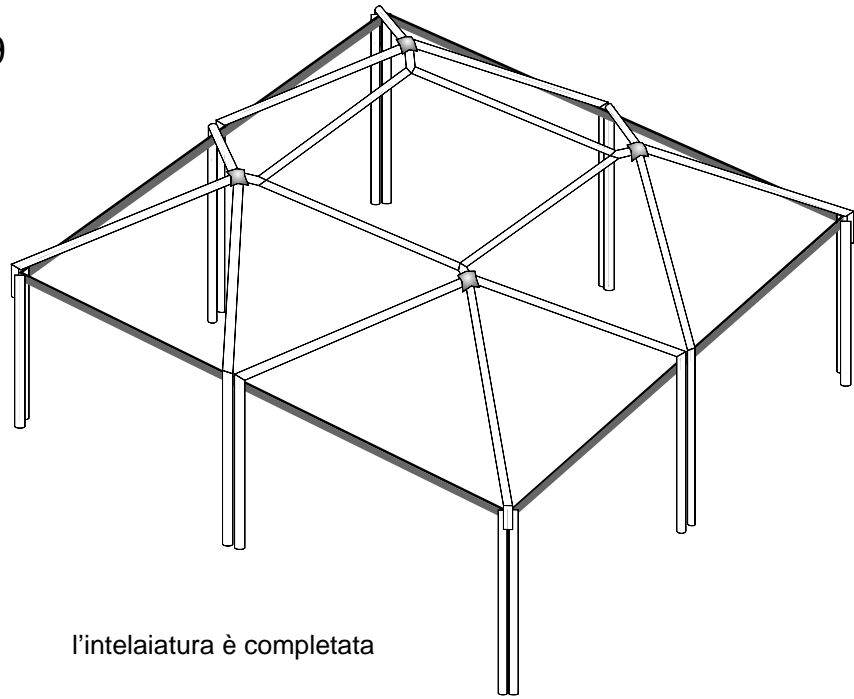

l'intelaiatura è completata

10

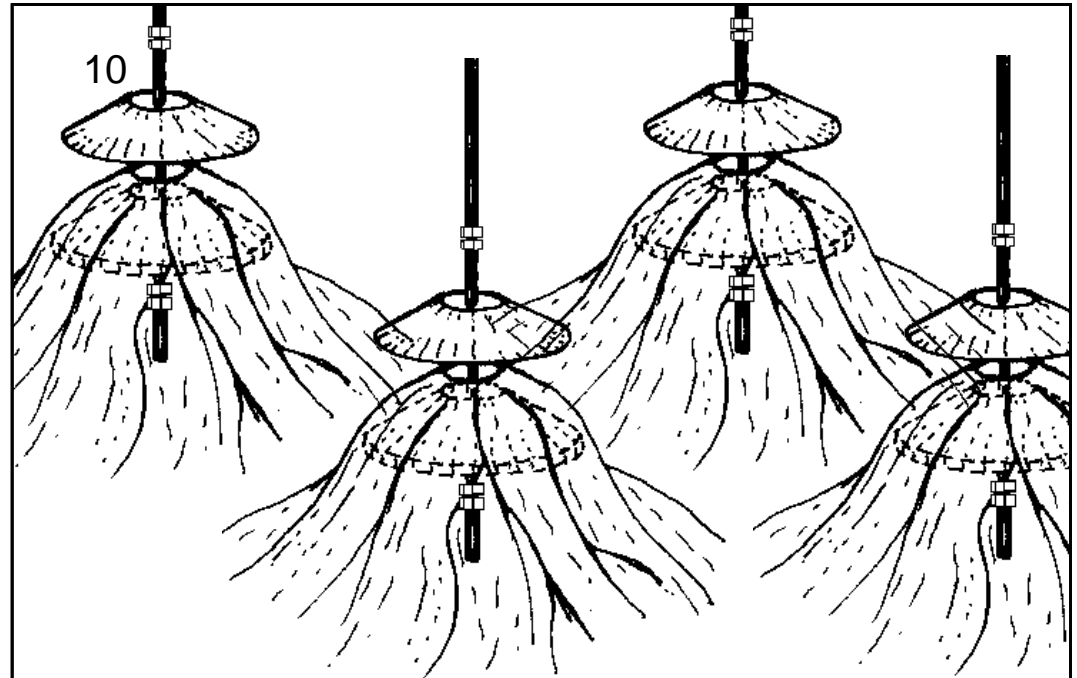

Bloccare le quattro cuspidi del telo tra le due calotte

11

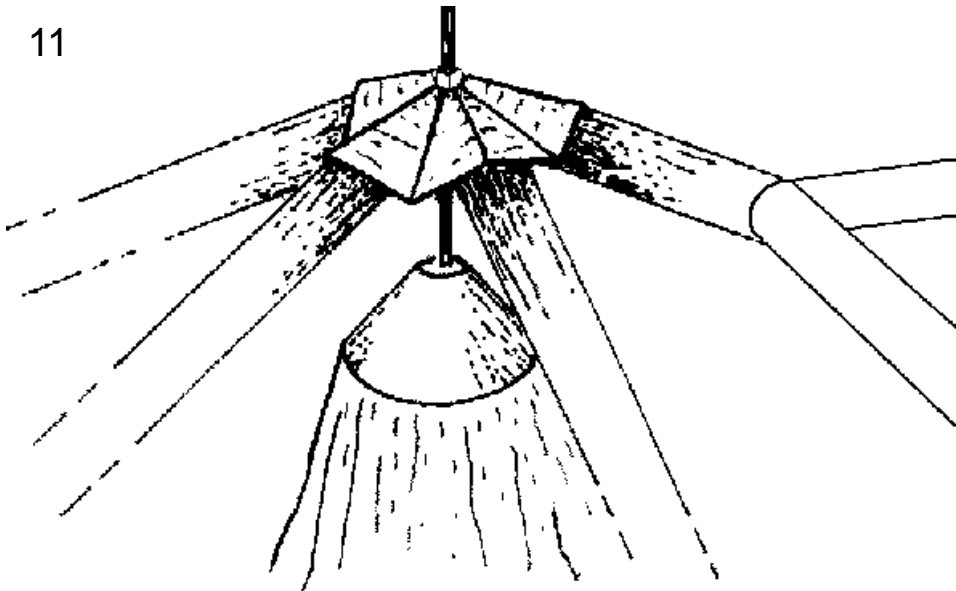

Abboccare l'asta filettata all'innesto in modo da appendere il telo

12

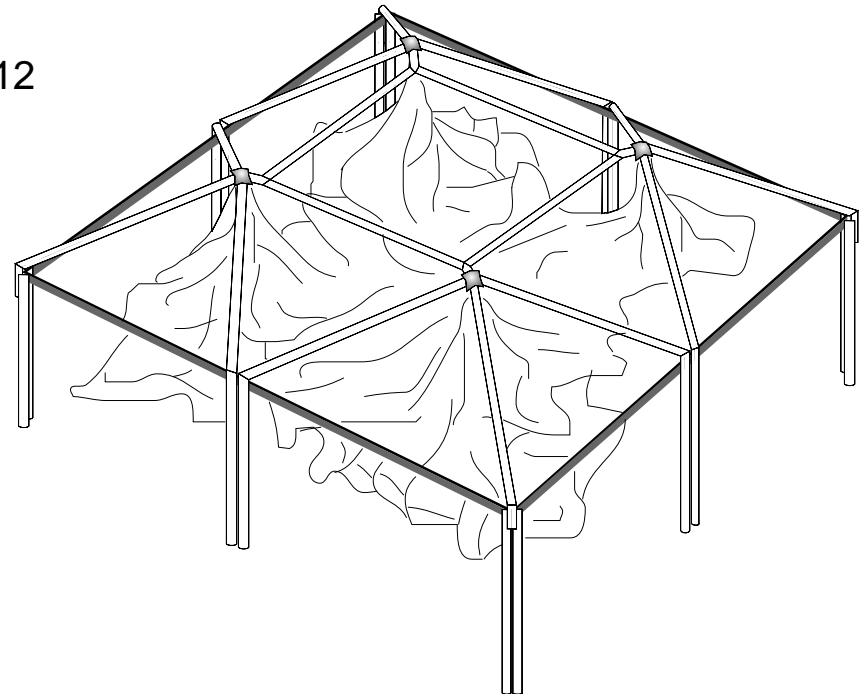

9

Posizionare il telo e bloccarlo per mezzo della cinghia
*Properly position the pvc cover and fix it against
the beam, as show on plan (12)*

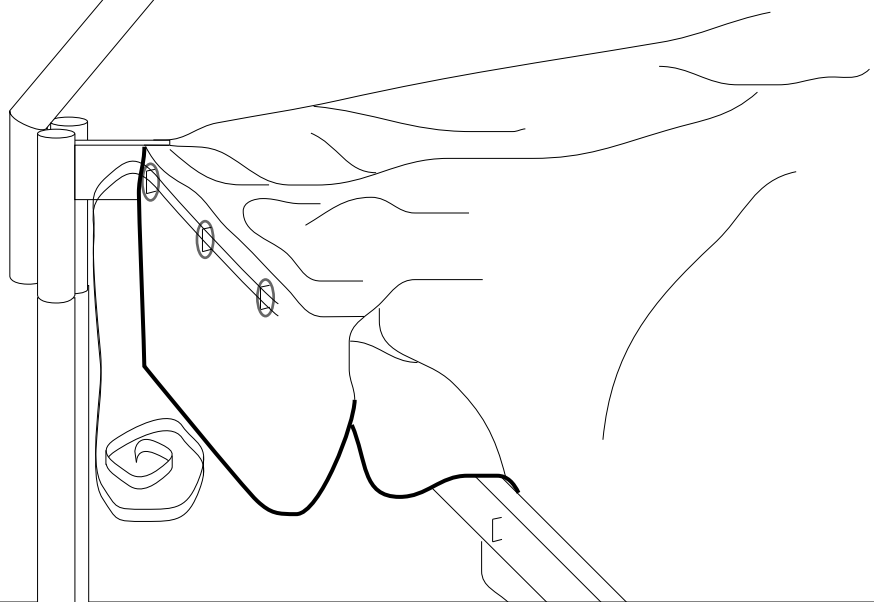

10

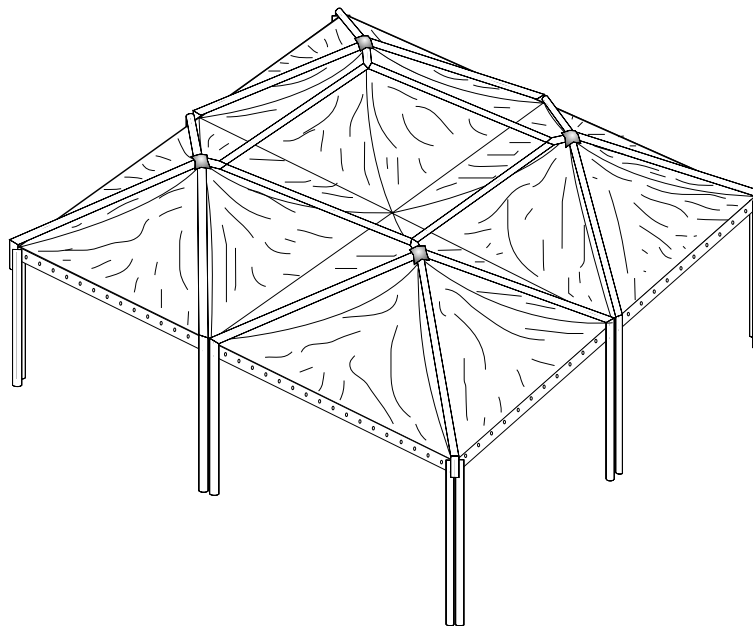

Ripetere l'operazione per tutti i lati della struttura

11

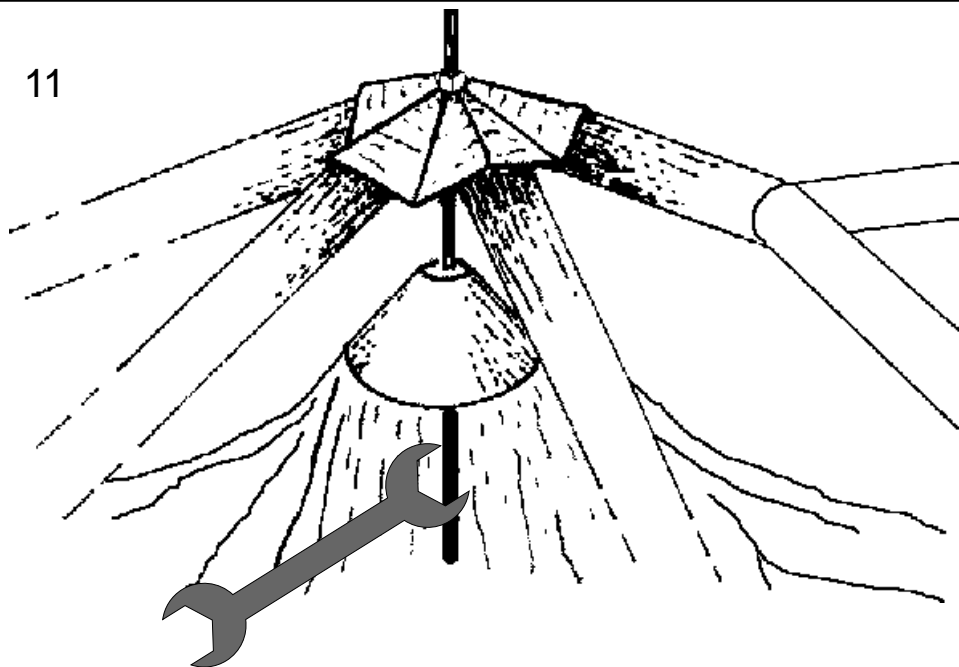

mettere in tensione il telo agendo dall'interno sull'asta filettata

12

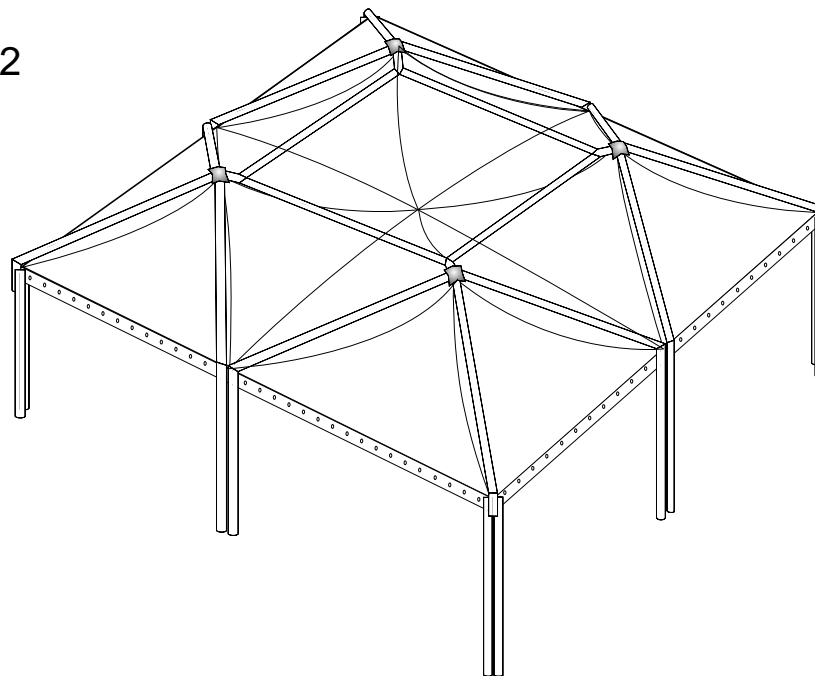

SCHEMA DE MONTAJ PENTRU MODELUL

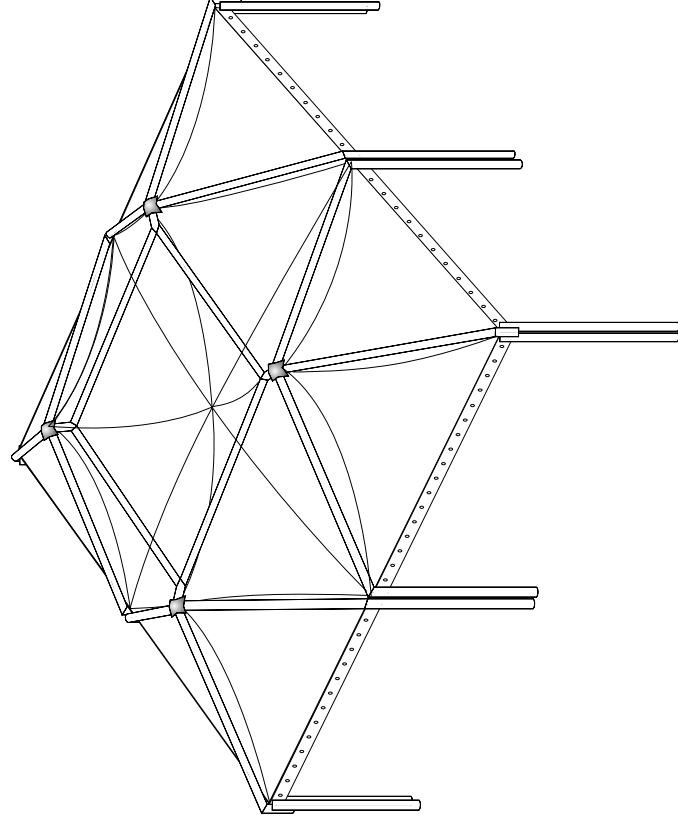

PAGODA 4 X 4